



M7
Shelving for picking



03 D

03 C

03 C

03 B



Storage system for manual picking of products following the "man-to-goods" principle.

Its main benefits are:

- Possibility of storing medium to heavy loads.
- Gauging between multiple levels of 25 or 50 mm, depending on the construction system used.
- Racks up to 20 m high can be built.
- Possibility of installing one or several gangways above ground to gain access to upper levels.
- Easy assembly.
- Excellent mobility.
- A wide range of components adaptable to your needs.

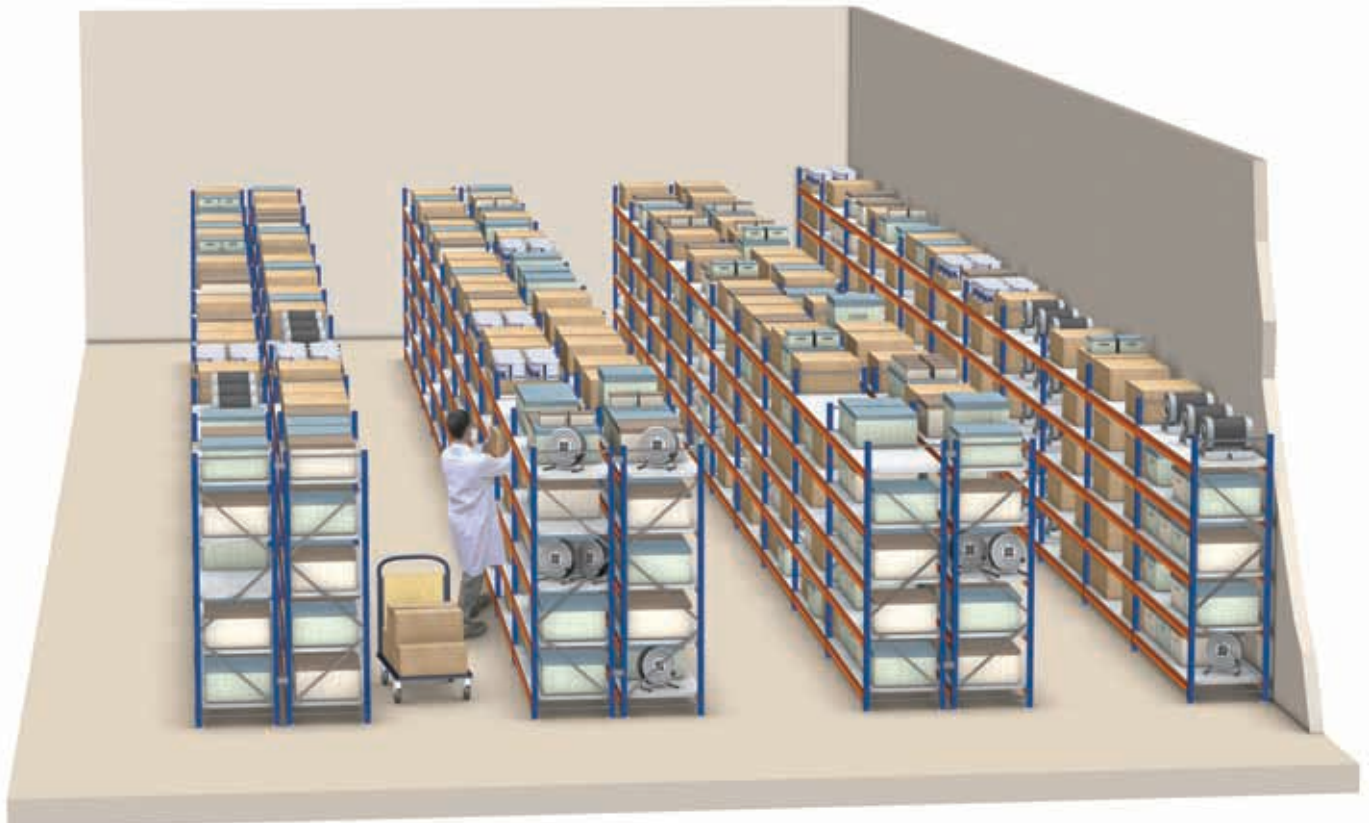

Basic structures

Three basic structures can be built from the different components. The components common to these three types of structures are the vertical frames, available in different profiles which are determined depending on the load to be supported.

The levels can be built in the following ways:

- With beams and shelves.
- With shelves and supports.
- Only with beams.

The choice of one structure over another depends on the product to be stored, and its dimensions and weight.

Levels formed using beams and shelves

Each level has a minimum of two beams fitted with shelves.

This is the ideal system to store:

- Boxes, packets or loose material.
- Heavy loads in medium-sized storage spaces.
- Medium-sized loads in large storage spaces.
- Bulky products.

The rigidity resulting from fitting the beams to the frames is usually sufficient to guarantee the stability of the racking, and therefore a basic rack only requires frames, beams and shelves. The latter may be made of metal, chipboard or mesh.





Levels formed using shelves and supports

The shelves are singular metal panels with reinforced edges which increase load capacity. There is also the possibility of fitting reinforcements in order to enhance this capacity.

The shelves are sustain by four supports fitted in the side slots of the frames, which in turn are secured in the corners of the shelf itself.

This system is ideal for:

- Storing boxes, packets or loose material.
- Medium-sized loads for light or medium loads.
- Classification compartments divided up by means of vertical dividers or drawers.
- Forming storage spaces closed on three sides.
- Minimum loss in height.

Longitudinal rigidity is achieved by means of vertical cross-braces fastened to the back of the racking. This construction system is most commonly used with M3 racking, but it is also used with M7 racking when an application has an increased number of levels and a greater load capacity.



Levels formed using only beams

Certain products do not require shelves for storage purposes, such as:

- Hanging garments.
- Hanging sample books
- Tyres, wheels and rims.
- Long and rigid articles.

Different types of beams enable the racking to be adapted to these products. A study needs to be carried out to ascertain if the rigidity of the join between the beams and uprights is sufficiently strong to guarantee the stability of the racking.



Components

The most commonly used construction systems are those which require beams and shelves in order to form a level, and those formed solely using shelves and supports. The differences can be seen in these two drawings:

Levels formed with beams and shelves (basic components)

- | | |
|-----------------------------|-----------------------------------|
| 1) Frame | 8) Mesh shelf cross-tie |
| 2) Beam | 9) Safety pin |
| 3) Galvanised picking shelf | 10) Frame union |
| 4) Chipboard shelf | 11) Chipboard Z-clamp |
| 5) Melamine-chipboard shelf | 12) Shim (levelling plate) |
| 6) Mesh shelf | 13) Anchor bolt (when applicable) |
| 7) Chipboard support | |

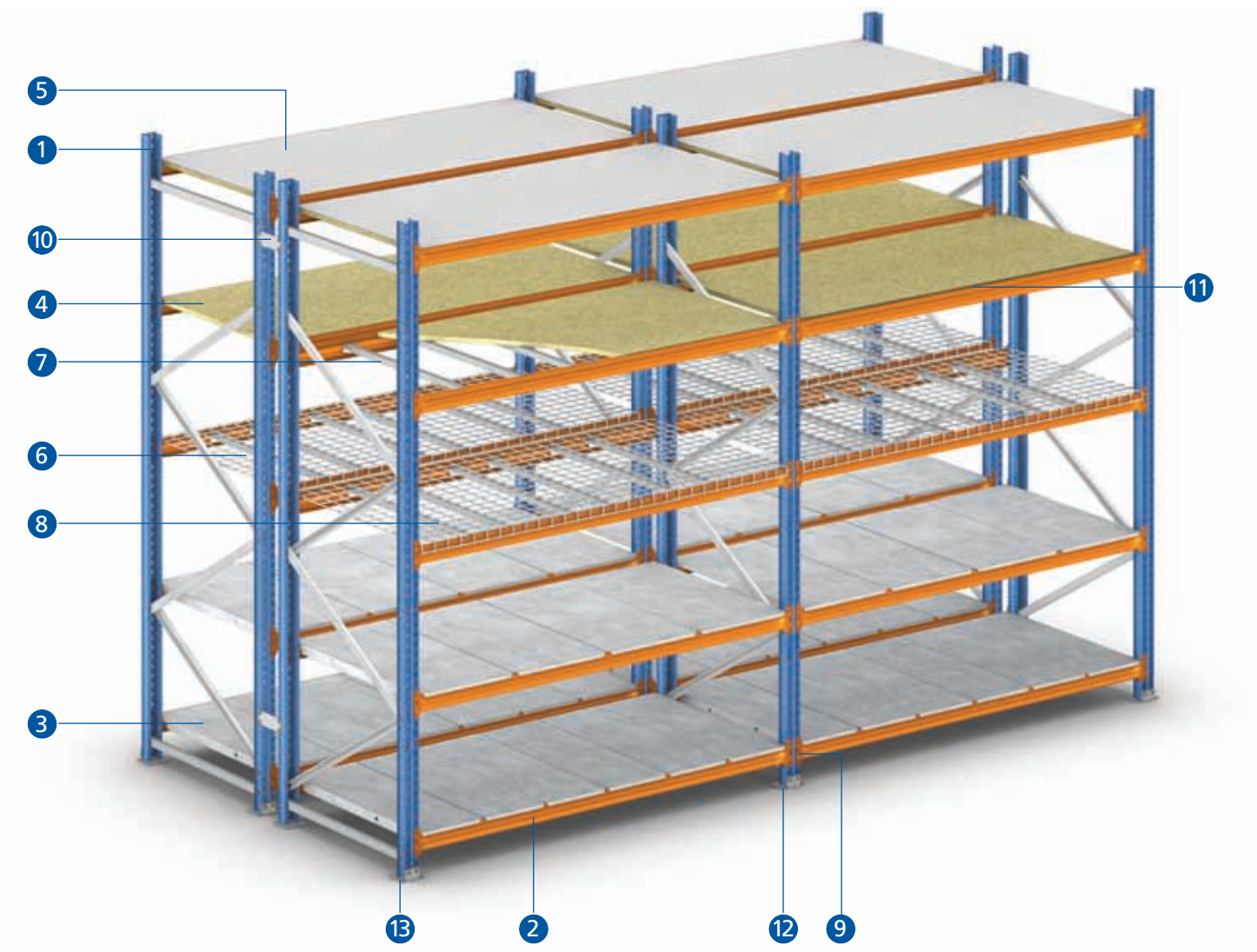



**Levels formed with shelves and supports
(basic components)**

- 14) Frame
- 15) HM shelf
- 16) Shelf support
- 17) Vertical cross-bracing set
- 18) Shim (levelling plate)
- 19) Anchor bolt (when applicable)
- 20) Frame union

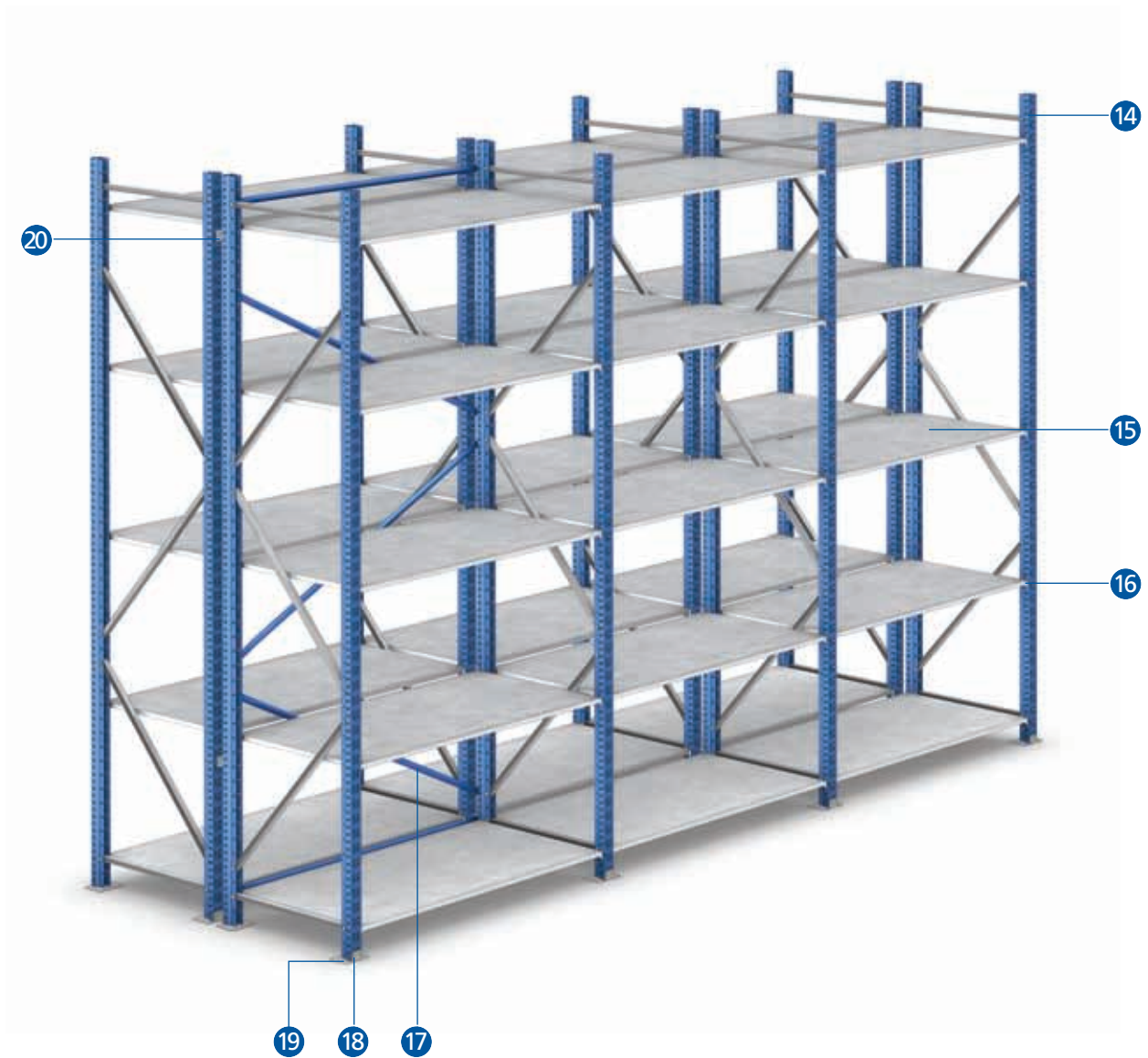

Levels formed using only beams

- 1) Frame
- 2) MS beam
- 3) Hanger beam
- 4) Shim (levelling plate)
- 5) Anchor bolt (when applicable)
- 6) Frame union
- 7) Safety pin

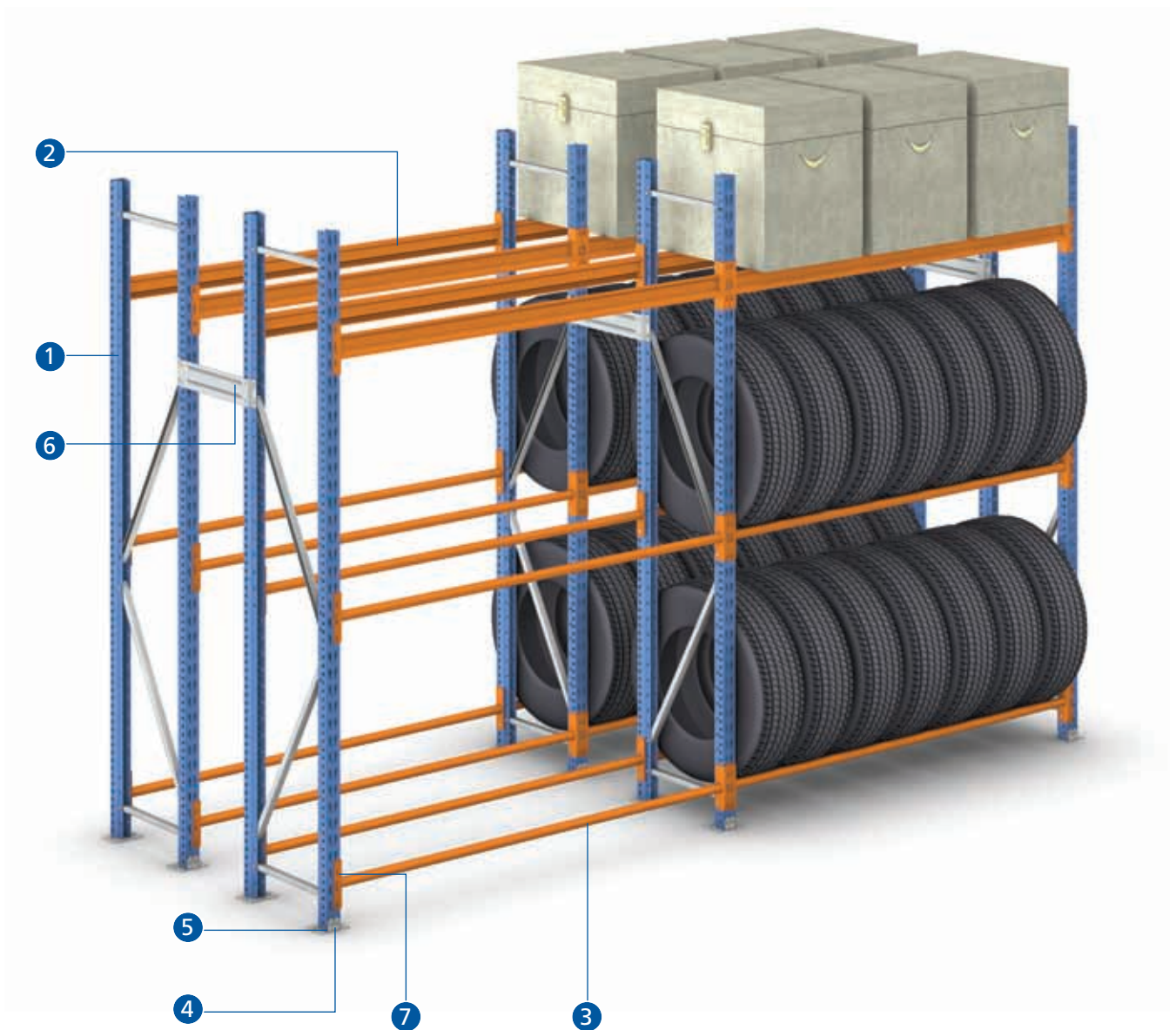



Units for hanging products

There are two solutions for hanging garments or other articles, one formed by hanger tube beams and another in which shelf levels are combined with supports and hanger tubes.

The following components are used for this type of solutions:

- 1) Frames
- 2) Hanger beams
- 3) Hanger tube supports
- 4) Hanger tubes
- 5) Supports
- 6) Z-profile beams
- 7) Shelves
- 8) Safety pins
- 9) Shims (levelling plates)
- 10) Anchor bolts (when applicable)

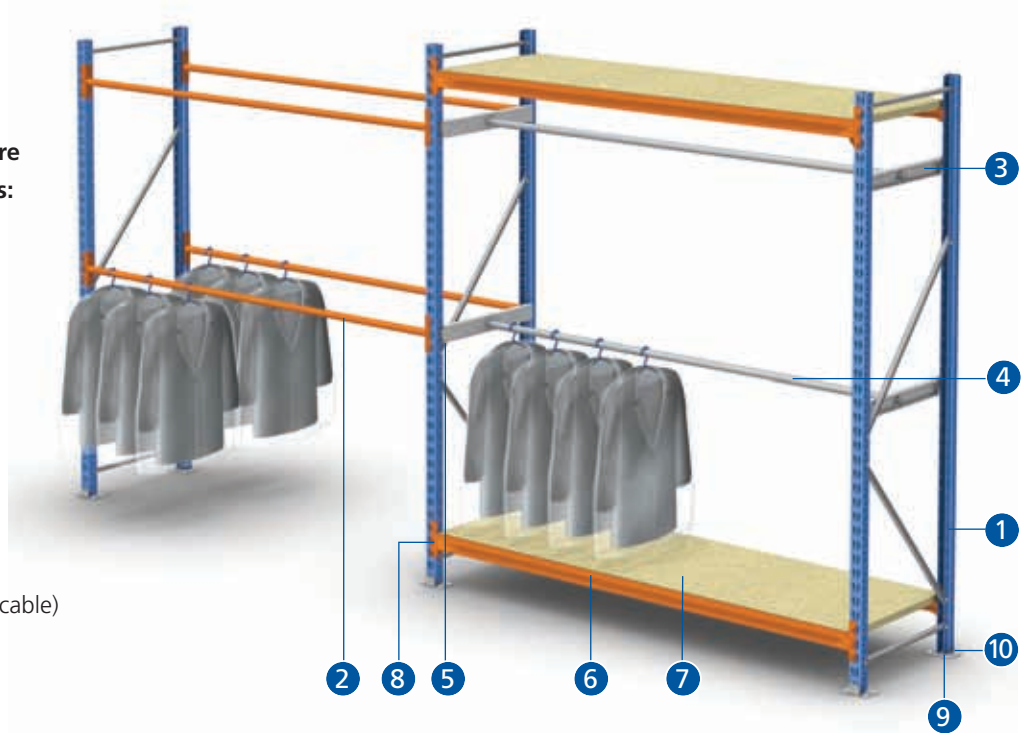

Components

Workbenches

Workbenches can also be built, for which the following components are available:

- 1) Frames
- 2) Top welded MS profile beams
- 3) Z-profile beams
- 4) Shelves
- 5) Worktops
- 6) Safety pin
- 7) Shims (levelling plates)
- 8) Brackets for the worktop

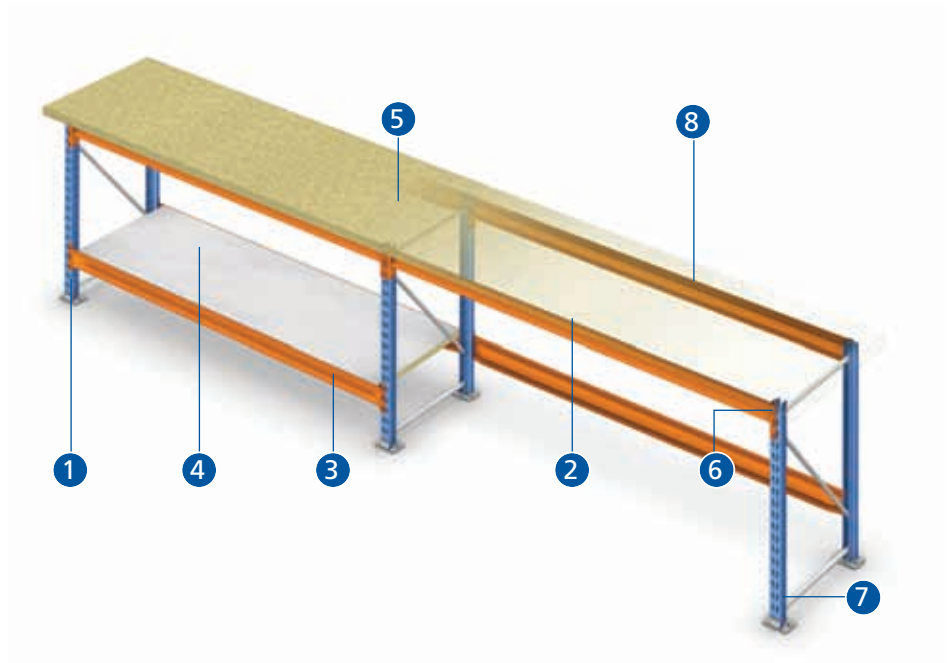

The worktops can be made from:

- Plain chipboard
- Melamine chipboard
- Melamine chipboard with edged wood





Most commonly used bays with beams

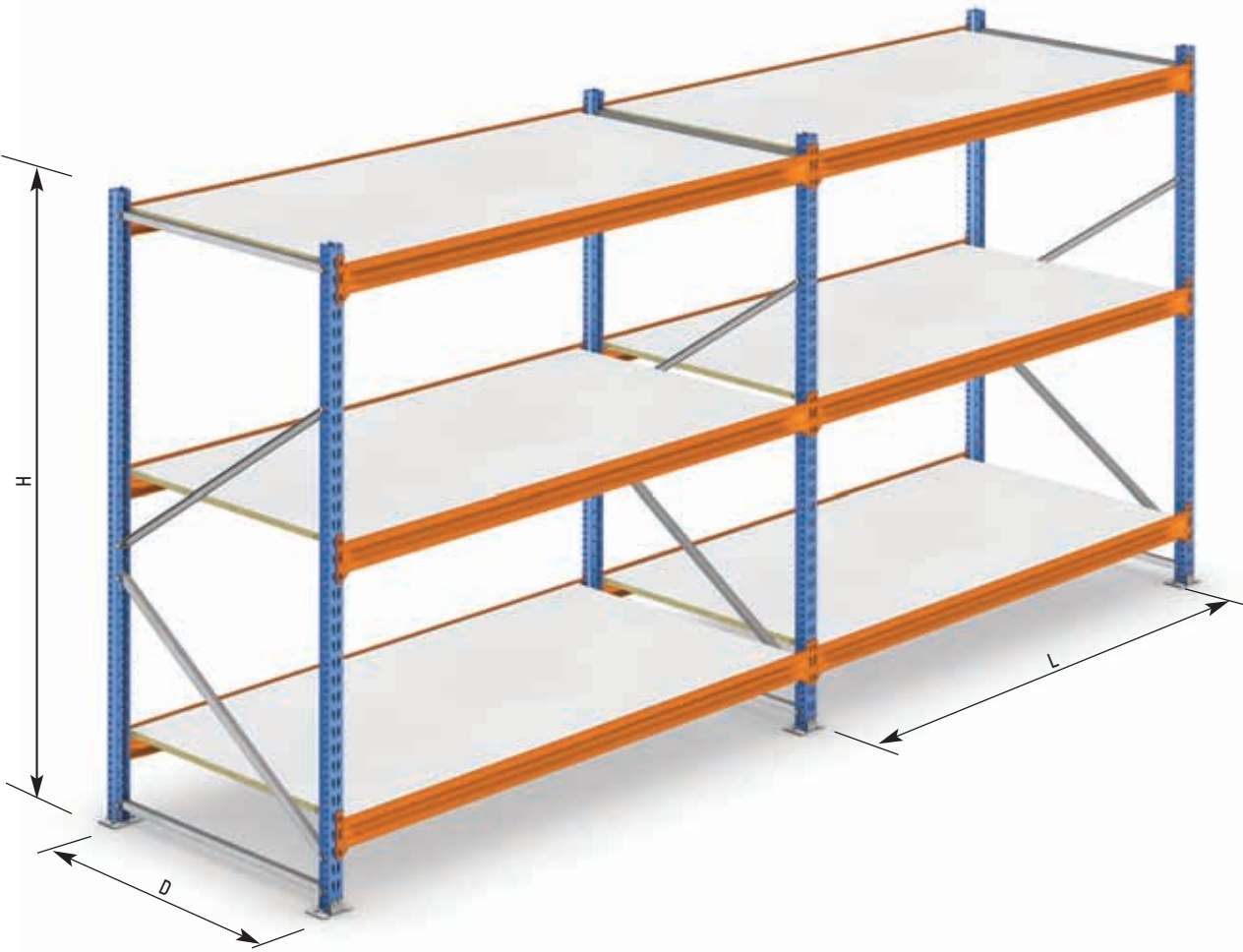

Most commonly used dimensions:

H = from 1000 to 8000 in multiples of 500 mm

L = 1000, 1200, 1400, 1900, 2300 and 2700 mm

D = 500, 600, 800, 900, 1000, 1100 and 1200 mm





Frames

Formed by two uprights with the corresponding bracings, footplates and accessories. They are slotted at intervals of 50 mm along their for the attachment of beams, and at intervals of 25 mm along their side in order attach HM shelves and accessories.

The different depth measurements enable the racking to be adaptable to sizes of the products to be stored.

The diversity of models, sections and thicknesses of uprights makes it possible to adapt to the most varied of loads.

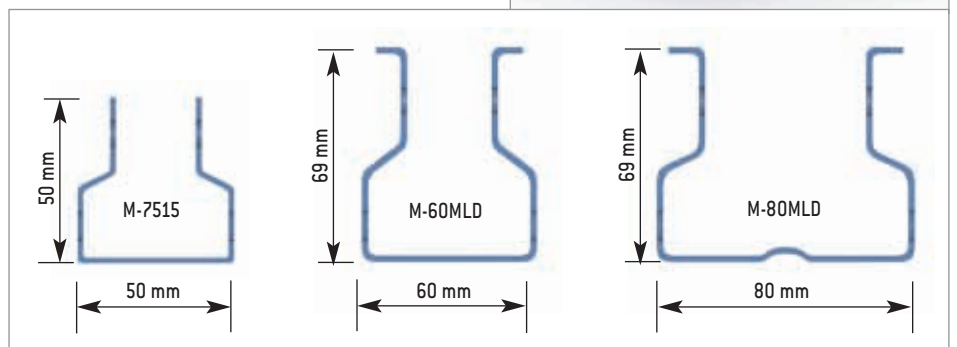

Profile models

Frame footplates

The frames are fixed to the floor by means of footplates which are placed at the base of the uprights. Different footplates are available in function of the upright model. Anchor bolts can be fitted when the rack requires this.

Shims (levelling plates)

Shims are used to level racks which are fitted on an irregular floor. Different plates are available for each type of upright and with different thicknesses to be able to level the racking with greater precision.

Anchor bolts

In order to fix the components to the floor, different anchor bolts are used, in function of the stresses the racking has to support and the characteristics of the floor itself.





Frame unions

Steel plates which are fixed to the uprights through the holes at their ends. Their function is to join the double runs, so giving them greater transversal stability.



Wall unions

When single bays run along a wall, the wall unions are used.



Frame splice

When the measurements of the installation in height do not permit frames with single-piece uprights to be fitted, frame splices are used which are bolted inside the uprights.





The beams are the horizontal components on which the load is directly deposited or on which the shelves are fitted in order to store small-sized products. They are joined to the uprights by means of connectors which fit into their slots. The hooks on these connectors, a connection system developed and patented by Mecalux, are fitted into the main body at both ends, which considerably increases the load capacity. Each beam includes two safety pins.

Mecalux has an extensive range of beams which covers any storage need, in terms of size, load type and capacity.

There are two types of beams:

Stamped beams

The connectors are formed by directly stamping the ends of the previously shaped profiles. This system, developed and patented by Mecalux, enables them to be process-manufactured, avoiding the need for welded joints, thus providing an unbeatable transmission of load.

These beams are Z-shaped with the top vertical edge shaped vertical in order to hold and secure the shelves. The most commonly used models are ZE-35, ZE-55 and ZE-65.



Welded beams

This is the classic system in which the profiles are welded to the connectors at the beam ends. This is done in those cases which require it because of the needs of specific sizes or uses. The most commonly used models are: ZS-35, ZS-55 and ZS-65 beams.



ZS-35, ZS-55, ZS-65 profile beams



MS-65 profile beams

These are used when the shelf protrudes from the racking.



Hanger or garment beams

These are used to hang garments or other articles or to support cylindrical objects.



Safety pin

This secures the beam in place eliminating any dislodgement.



Galvanized picking shelves

The most commonly used combination is to fit metal shelves with Z beams.

A level is made up of several shelves of widths varying in function of the length of the level and the weight of the product to be stored.

The shelves are supported on the beams, with the vertical edge also being engaged, which enables both beams of a single level to be joined. All of this gives the racking greater rigidity.

The different shelves which make up a level slot perfectly into each other thanks to the indentations and side slots.

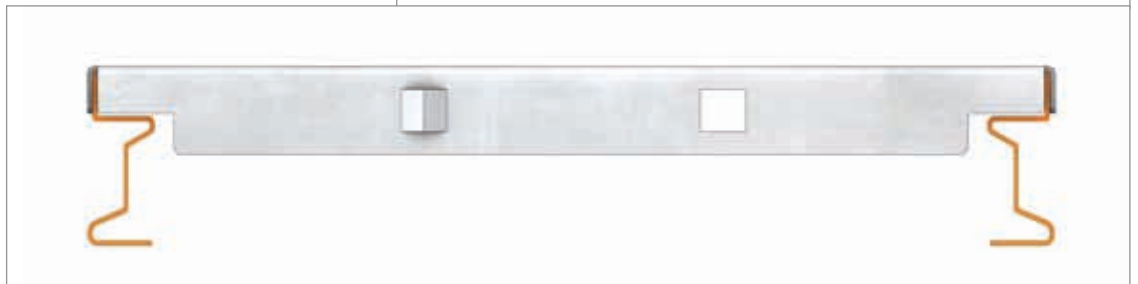

Picking shelf dividers

These are vertical metal separators which are fitted between two shelves of the upper level and two shelves of the lower level, thus creating compartments within the same level. They can be moved from side to side, enabling the size of the storage space to be adjusted.



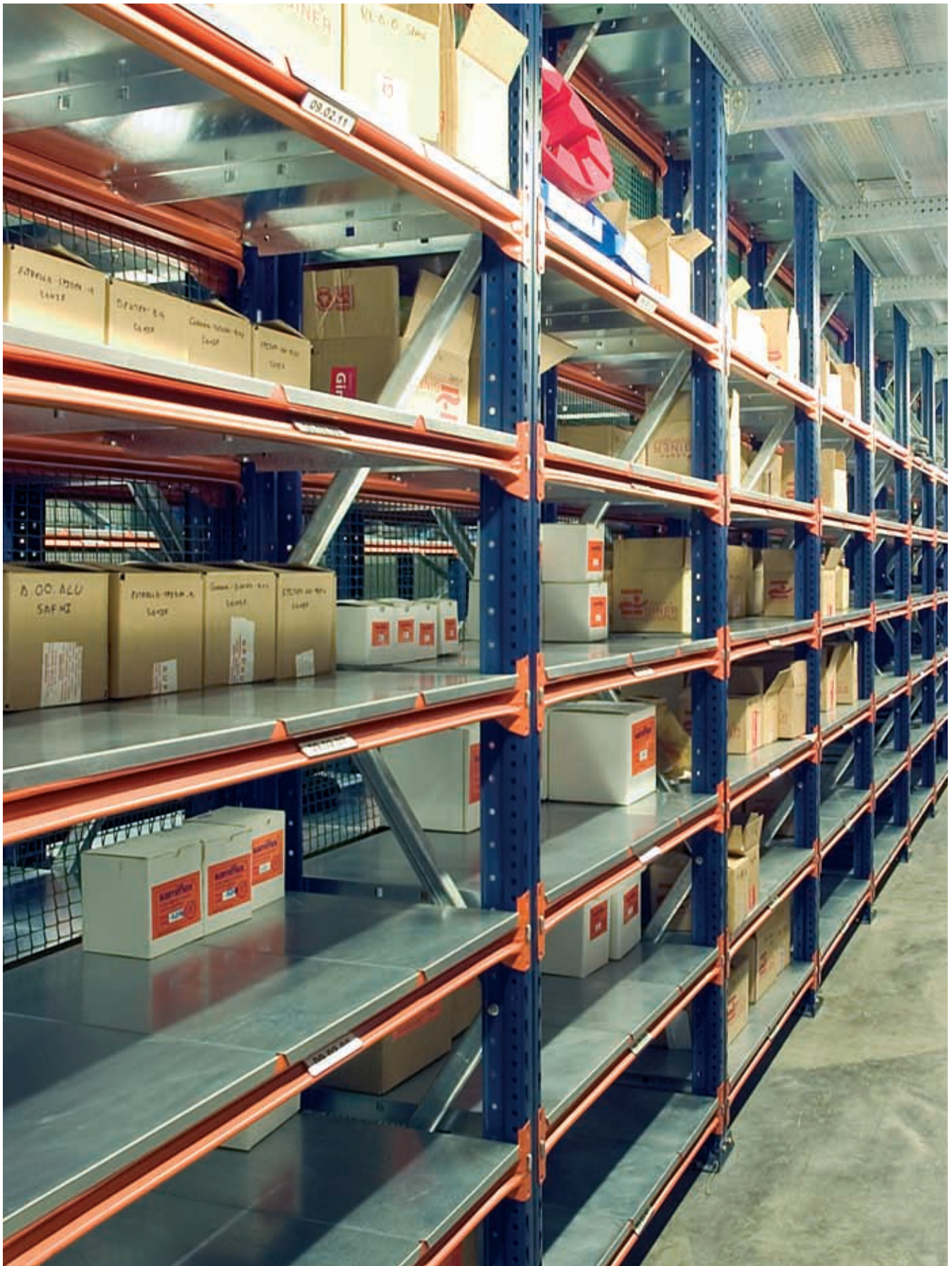

Chipboard shelves

Chipboard shelves

They are fitted between the two ZE or ZS beams, and their front edge is concealed by the vertical edge of the beams.

The chipboard shelves are also available in a white melamine finish.

Chipboard supports can also be fitted if the load requires this.



Chipboards Z-Clamps

In levels equal to or more than 1900 mm, chipboard-Z clamps are used to make the two beams flush with the chipboard shelf and to give the unit greater rigidity.

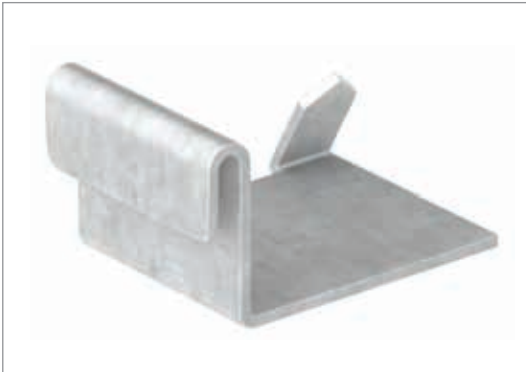

Chipboards support bars

These are metal pieces which are stamped at their ends to ensure that the shelves are properly supported on the beams.

They increase the load capacity of the chipboard shelves.

They rest on the two beams of the same level below the chipboard shelf. The number used varies in function of the load to be supported.





Chipboard shelves

Double deep chipboard shelving

When a level has a considerable depth and the shelf is a single piece, it is necessary to assemble a unit as shown in the diagram below. That is, ZE or ZS beams at the ends and MS beams in the centre need to be fitted.



Vertical chipboard dividers

They form smaller compartments within the same level. They are manufactured in plain chipboard or melamine finish.

Two upper and two lower clamps are required to fit them to their respective shelves.

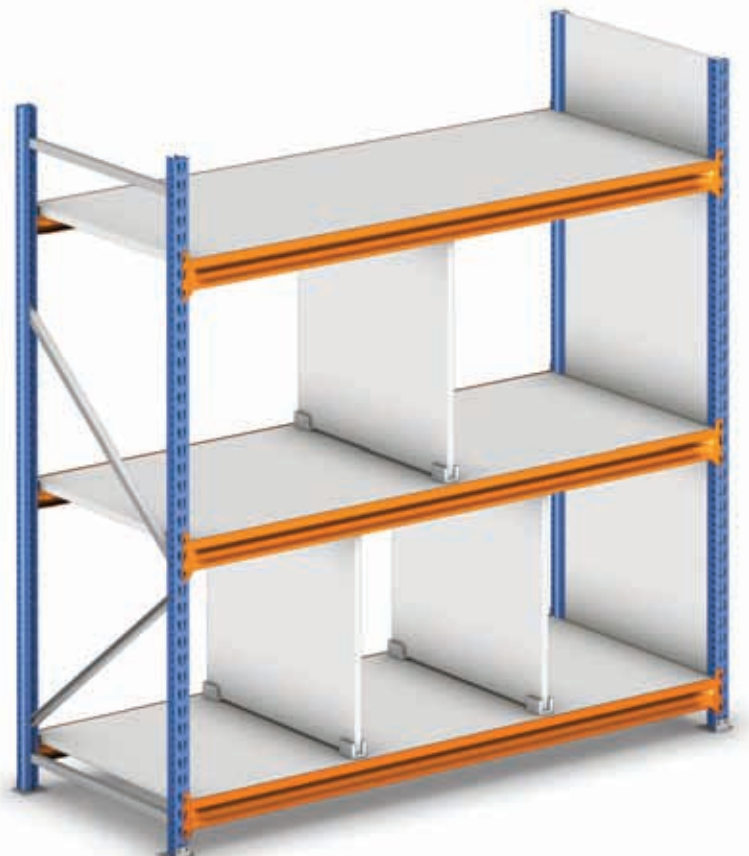
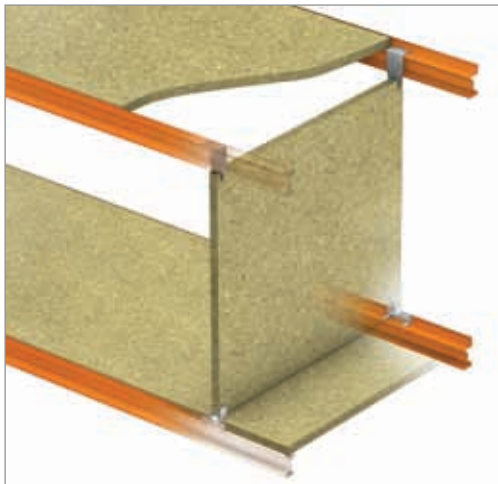

Racking with melamine chipboard dividers



Mesh shelves

They are formed by rectangular electro-welded mesh pieces supported on the ZE or ZS beams and on the mesh supports. The shelves are clipped to the vertical edges of each beam, joining two beams of the same level together, and thus giving the unit greater rigidity.

The number of supports which must be fitted varies in function of the load to be stored. The mesh is fitted to the supports by means of mesh shelf clips.

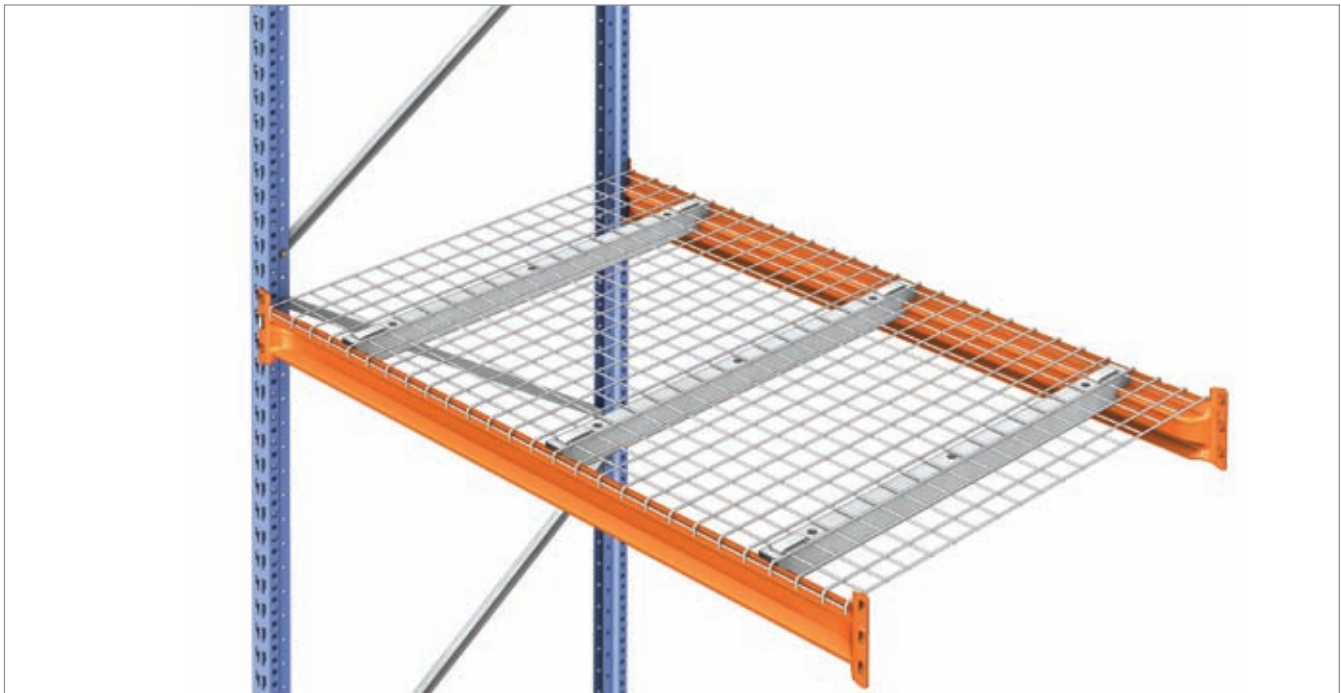

Mesh shelf clips.



Mesh shelf supports.

HM Shelves and accessories

HM Shelves

The levels can be formed using just HM shelves, without the need to fit beams. These are supported on each corner using shelf supports, which are fixed to the side holes of the uprights.

HM shelves are manufactured in a single piece, in galvanized sheeting, formed by several folds, giving the shelf a greater load capacity both at the front and the side.

The shelves come with slots punched above and below which enable dividers and accessories to be fitted.

The most common sizes are:
L = 1000, 1250 and 1400 mm
D = 300, 400, 500 and 600 mm



The groove along the front part serves as a support for labels or as a magnetic label holder.



Shelf reinforcement

The HM shelves can be fitted with a longitudinal central reinforcement in order to increase load capacity.





HM Beams

The basic function of these beams is to increase the longitudinal rigidity and stability in high-bay racking units built with levels of HM shelves.

In addition, they can be used to increase the load capacity of the shelves.



Vertical cross bracing

This is required when the racking units are built using HM shelves in order to guarantee longitudinal stability.

They comprise of tubular profiles with specially shaped ends, bolted to the front slots of the uprights. The number of braced bays depends on the length and height of the racking units and the weight of the stored product.

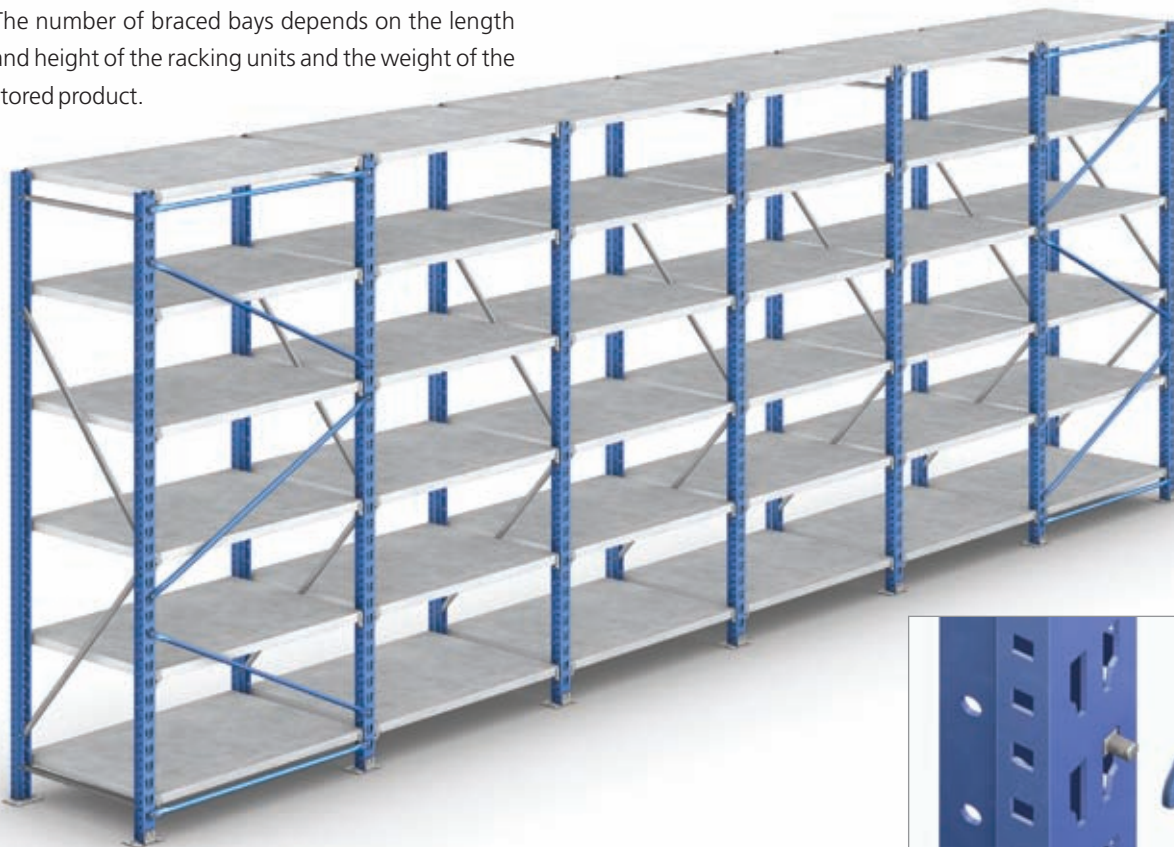

Back view

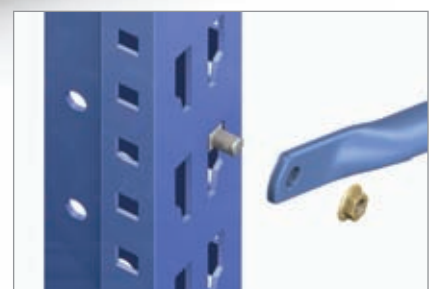

Cross bracing union.

Hanger tube supports

Hanger tube

This piece fits into the hanger tube supports which either comprise of a single or double function depending on the requirements.

The set rests on four PK supports, which have been previously hooked into the inner side slots of the uprights.



The double tube hangers can also be used to hang products, or to support cylindrical objects such as tyres.



The single hanger tubes are used to hang products or items such as garments.

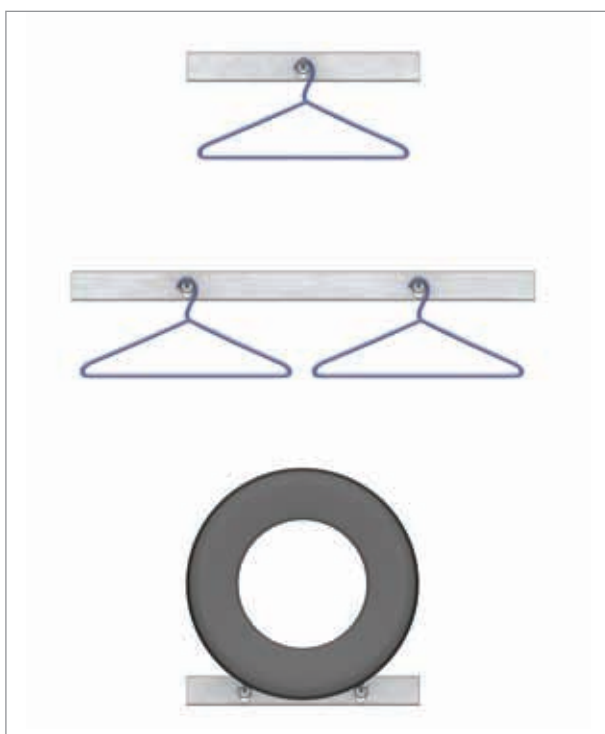



Side and back mesh

Mesh panels can be fitted to the side of the racking units to prevent products from falling or getting mixed up with products from other levels.

They are fixed to the uprights of the racking units.

Likewise, mesh panels can also be fitted at the back of the racking unit with the same function.

They are fixed to the uprights using PK clamps.



Back view

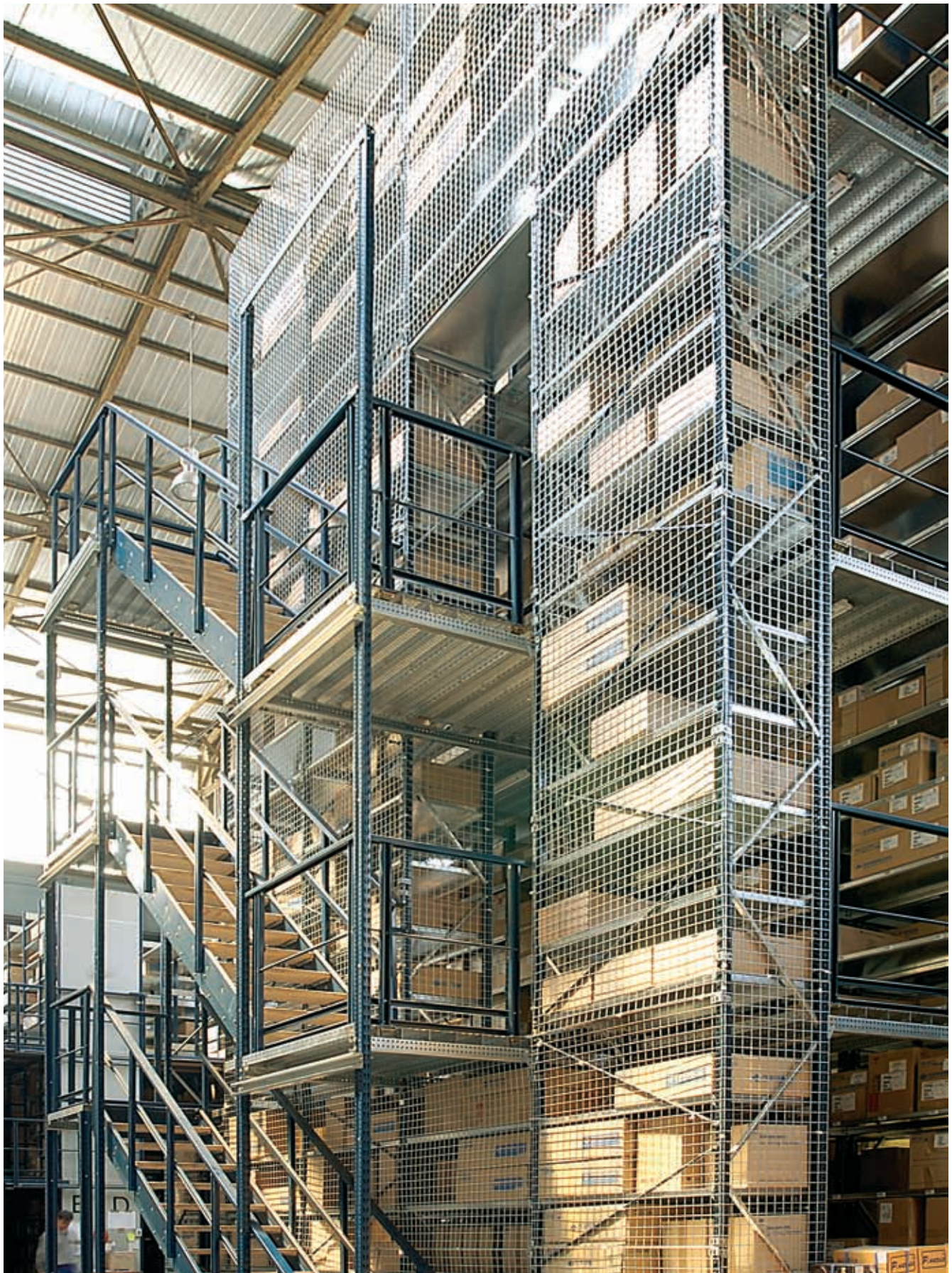

Wooden side panels

Wooden side panels

Frames can also be built using uprights and wooden side panels to prevent the product stored from falling or getting mixed up with other levels. A melamine finish to the panels is available to improve the appearance of the rack.





Magnetic label holders

Magnetized plastic profiles which are fitted at the front of the HM shelves in order to highlight or signal the levels or the compartments formed in the levels, or to identify the products stored. They are fitted into the front groove in the shelves. Two models are available:

Model A – Front surface finished in white plastic, which enables it to be written on with a permanent marker pen.

Model B - Profile with two guides designed so that a changeable label of the same width as the sign can be inserted. This label is protected by a plastic sheet which is slipped over the label using the same guides.

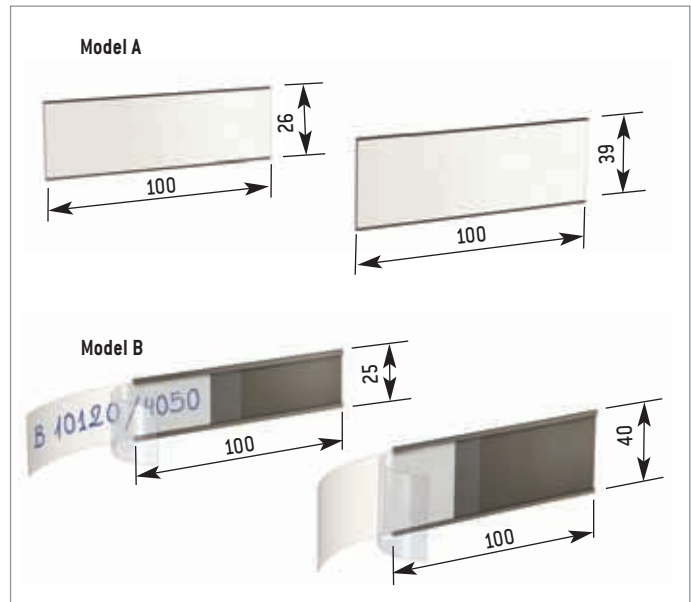

Sign plates

Rectangular plaques fitted at the ends of the racks and used to identify areas by means of letters or numbers.



Identification labels

These are plates used to identify the technical characteristics of the facility.

They are placed in visible areas at the end of the racks.

Other solutions

The system enables other types of solutions which have not been considered in this catalogue, but which can be put into practice after a study has been carried out on the client's needs.

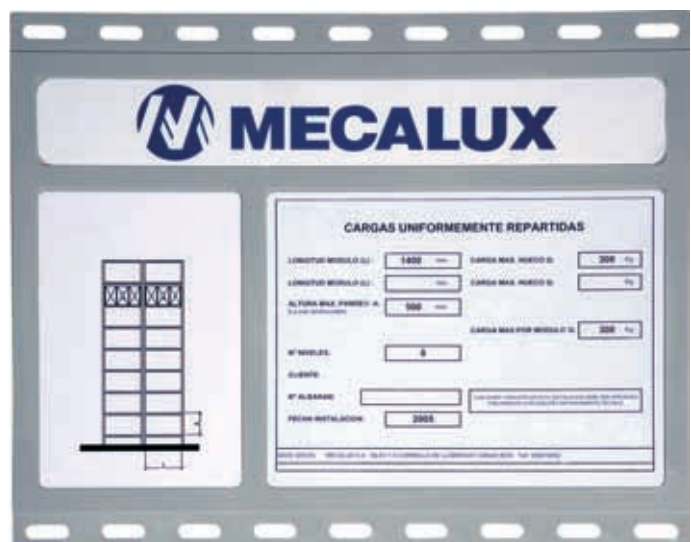

Slotted shelf dividers

Vertical separators which enable compartments to be built in the levels formed by HM shelves.

They are fixed into the slots of the shelves and can be fitted in two different ways:

- By fixing them to the top and bottom shelf, thus dividing the total height.
- By fixing them only to the bottom shelf.

For more information on HD dividers, please refer to the M3 shelving catalogue.

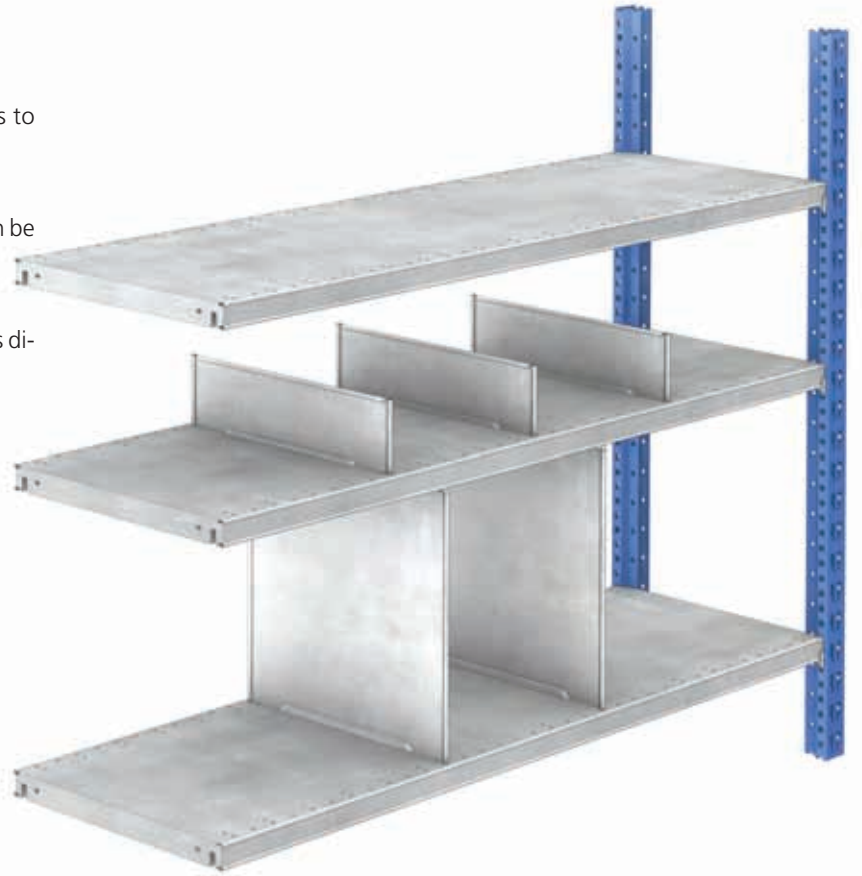

Removable plastic bin drawers

Adapted to the racking bays, they enable small objects or products to be stored and classified.

The careful design of their shape, the reinforcements, the slots for separators, the retention system, the label holder, the resistance and the ease of access to the handle, etc. all make these drawers the ideal complement to the longspan system for small products.

The drawers are manufactured in polypropylene, which gives them an excellent load capacity and resistance to handling.

For more information on plastic bin drawers, please refer to the M3 shelving catalogue.







MK-056519-06/11 - ©MECALUX, SA



LONDON - MECALUX UK Ltd.
 Unit 39, Halifax Road
 The Metropolitan Park,
 Greenford Middlesex UB6 8XU
 Tel. 020 8575 1007 - Fax 020 8575 0705

BIRMINGHAM - MECALUX UK Ltd.
 Unit 9, Network Park Industrial Estate
 Duddeston Mill Road
 Saltley, Birmingham B8 1 AU
 Tel. 020 8575 1007 - Fax 020 8575 0705

HEAD OFFICE - MECALUX, SA
 Silici, 1
 08940 Cornellà de Llobregat
 Barcelona (SPAIN)
 Tel. + 34 932 616 913 - Fax + 34 932 632 682

Argentina, Belgium, Brazil, Canada, Chile, Czech Republic, France, Germany, Italy, Mexico, Netherland, Poland, Portugal, Slovakia, Spain, USA

e-mail: info@mecalux.com / www.mecalux.com

